

# 100M atom electronic structure calculation of organic device materials on full system of K Computer

Takeo Hoshi and Hiroto Imachi (Tottori U)

1. Introduction : organic device materials
2. Method
3. Result
4. Comment on further collaboration  
between application and HPC researcher
5. Conclusion

---

## Acknowledgement for collaboration

Organic materials : M. Ishida ( Sumitomo Chemical Co. )

Mathematics: : T. Sogabe, S. L. Zhang ( Nagoya U )

Tuning (recent) : K. Kumahata, M. Terai, K. Miyamoto, K. Minami, F. Shoji (RIKEN-AICS)

National project : 'Post K' application project

# Introduction : organic material and flexible devices

Organic material gives the foundation of flexible ultra-thin devices of IoT products, like display, battery and sensor ( thickness  $\leq 1,000$  nm )

Ex. 'Rollable' (ultra-flexible) display,  
Sony, News Release,  
26. May. (2010)

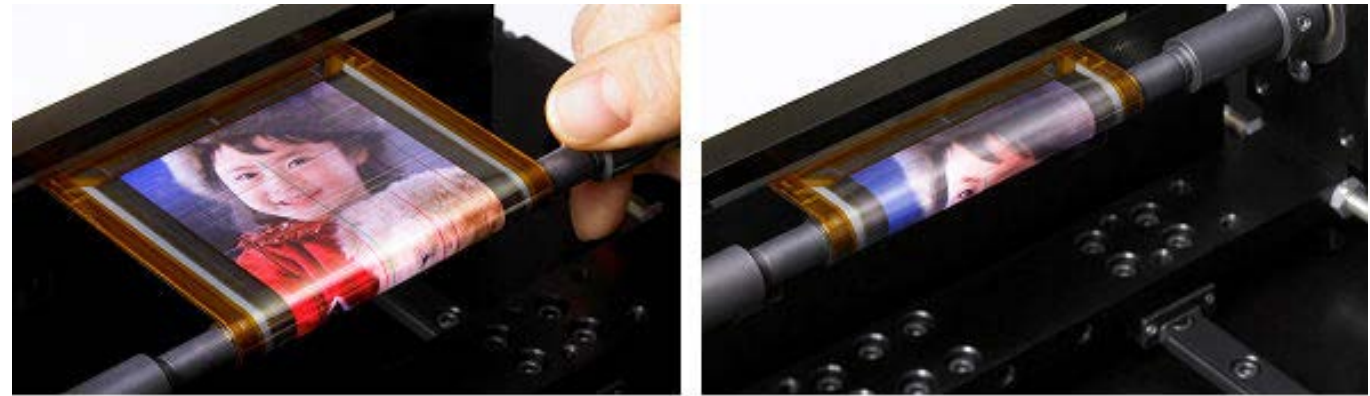

Ex. 'e-skin' (U Tokyo)  
T. Yokota, et al.,  
Sci. Adv. 2, e1501856 (2016)  
( wearable device  
monitoring your health )

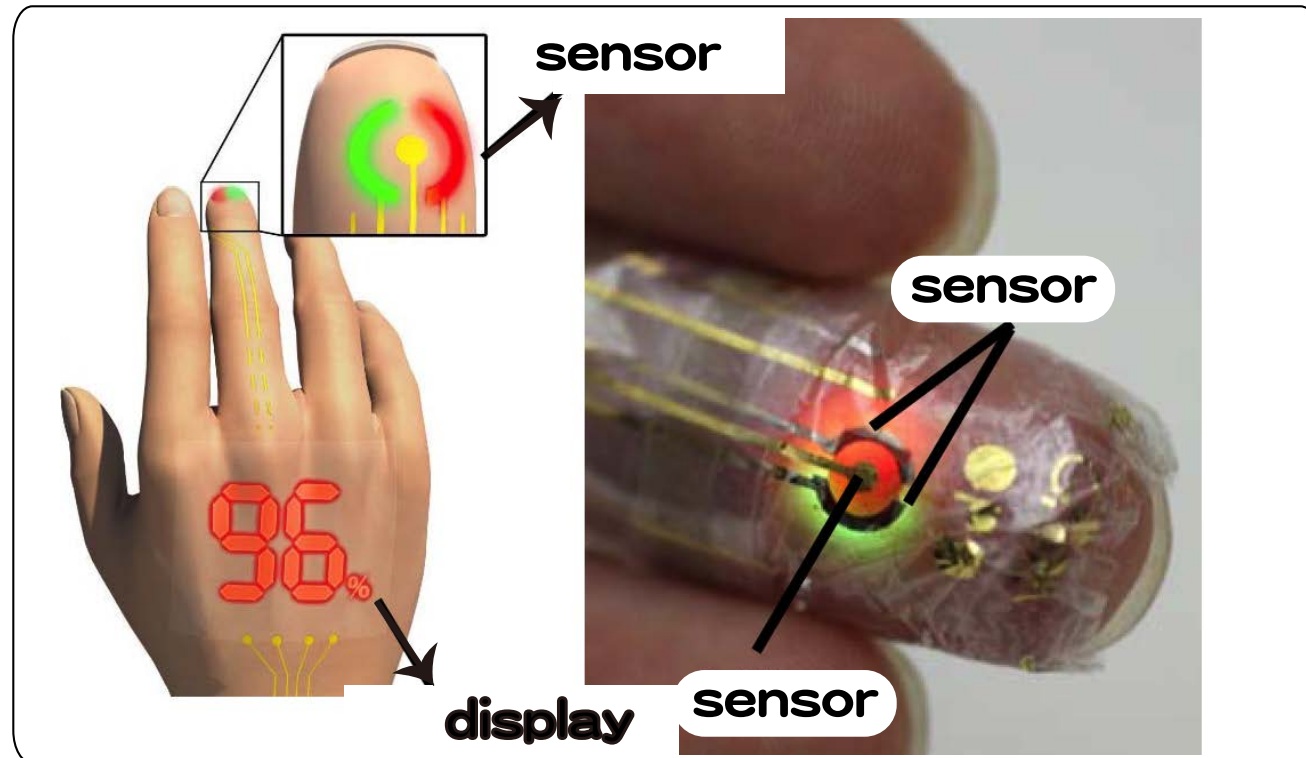

# Organic device material and 100-nm-scale quantum simulation

Organic device material

- semiconductor with ' $\pi$ -type' electronic wave that lines in benzene rings and so on  
→ strong anisotropy

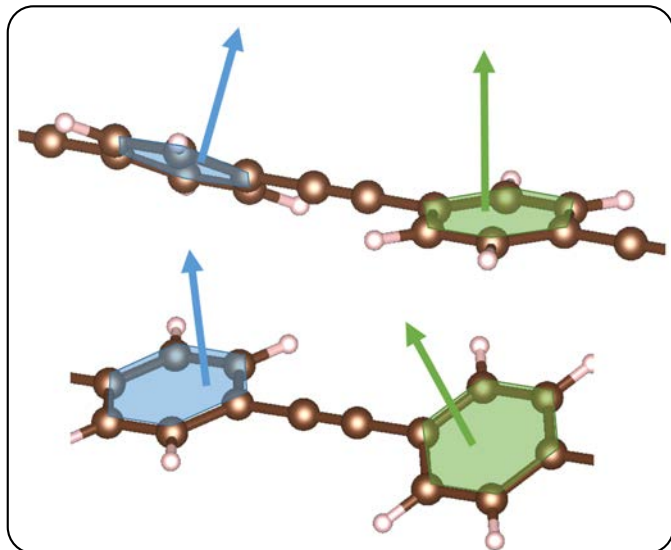
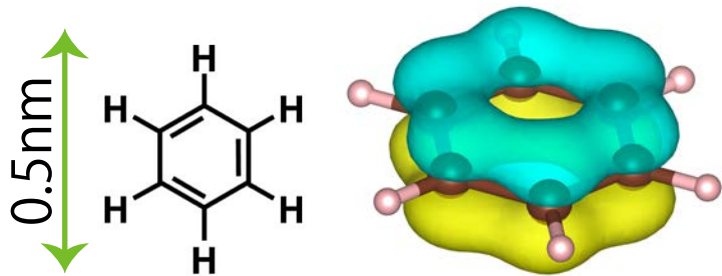

Pioneering experimental research in 1970's



The Nobel Prize in Chemistry 2000:  
'discovery and development  
of conductive polymers'



A. Heeger, A. G. MacDiarmid, H. Shirakawa



# Organic device material and 100-nm-scale quantum simulation

Organic device material  $\longrightarrow$  Scales between device and 100-nm-scale simulation

- semiconductor with ' $\pi$ -type' electronic wave that lines in benzene rings and so on  
 $\rightarrow$  strong anisotropy

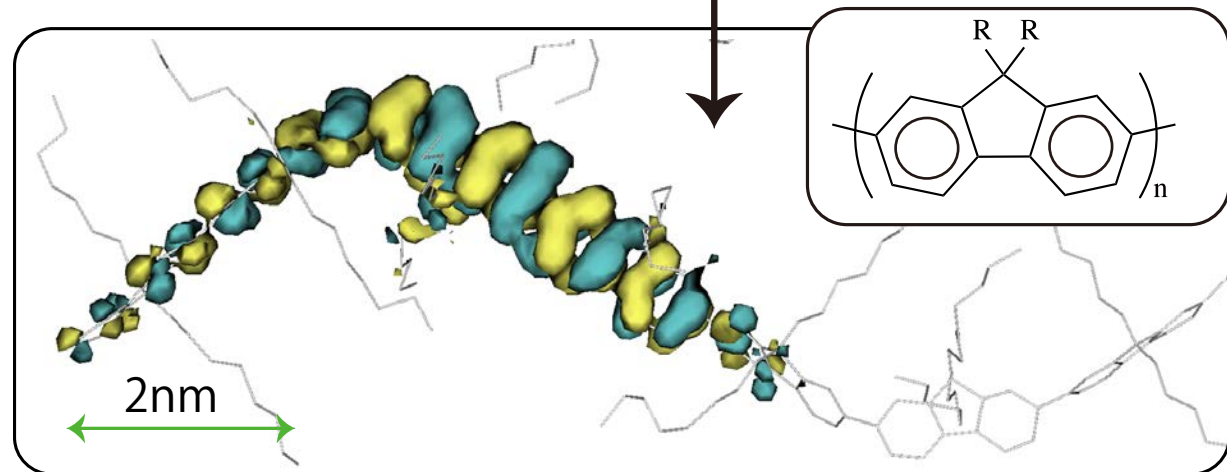
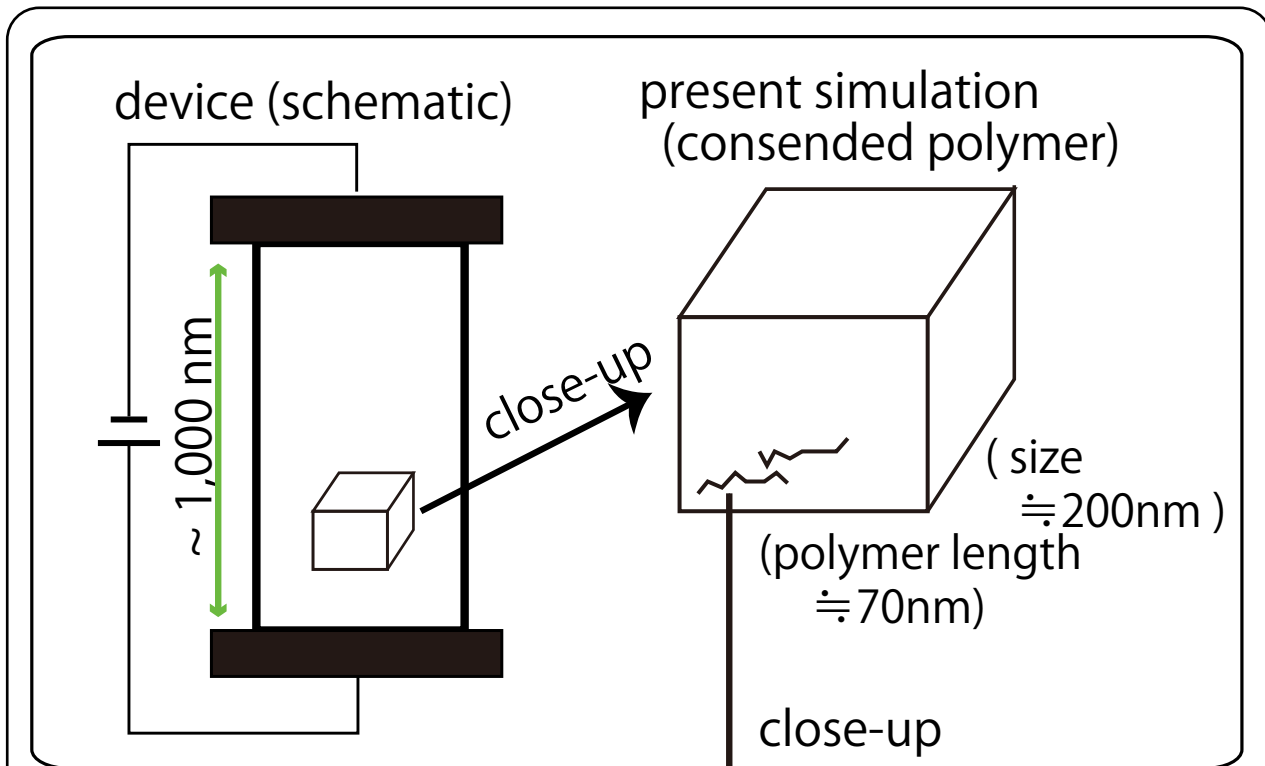
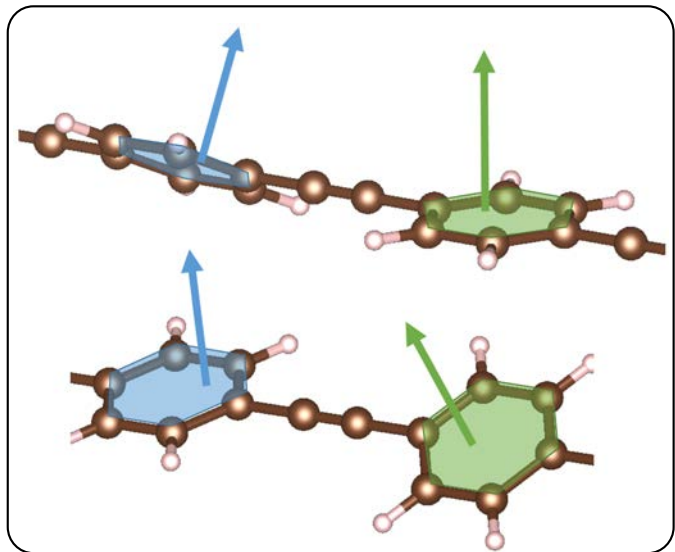
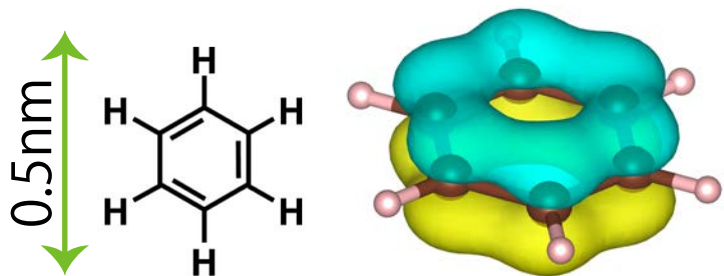

# Organic device material and 100-nm-scale quantum simulation

Organic device material  $\longrightarrow$  Scales between device and 100-nm-scale simulation

- semiconductor with ' $\pi$ -type' electronic wave that lines in benzene rings and so on  
 $\rightarrow$  strong anisotropy

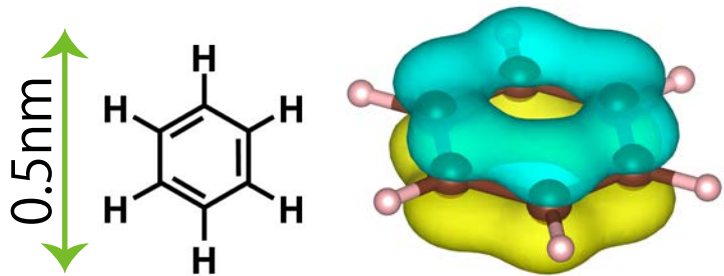

Industrial problems can be solved by 100-nm-scale or 100-million-atom quantum (electronic structure) simulations

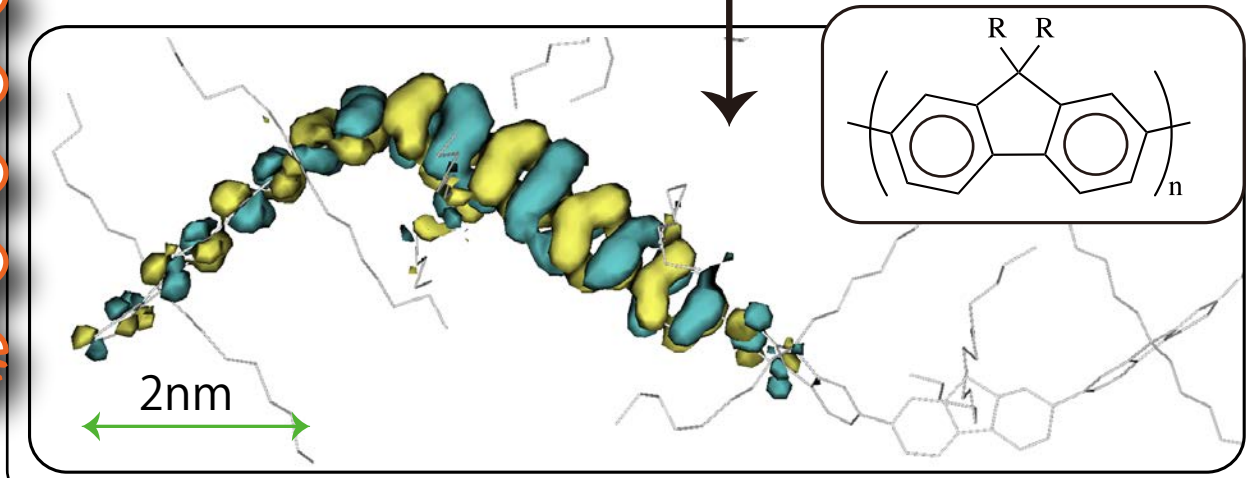
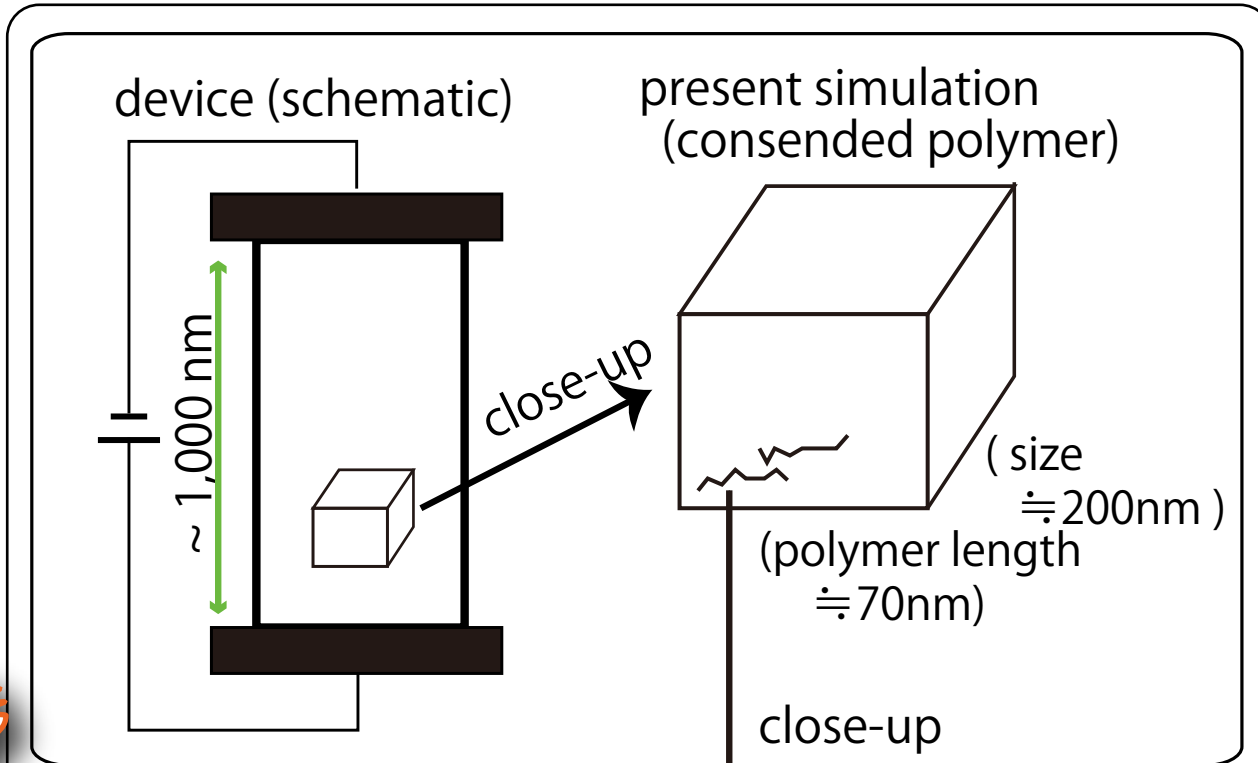

# 100M atom electronic structure calculation of organic device materials on full system of K Computer

Takeo Hoshi and Hiroto Imachi (Tottori U)

1. Introduction : organic device materials

2. Method

3. Result

4. Comment on futher collaboration  
between application and HPC researcher

5. Conclusion

---

## Acknowledgement for colloboration

Organic materials : M. Ishida ( Sumitomo Chemical Co. )

Mathematics: : T. Sogabe, S. L. Zhang ( Nagoya U )

Tuning (recent) : K. Kumahata, M. Terai, K. Miyamoto, K. Minami, F. Shoji (RIKEN-AICS)

National project : 'Post K' application project

# ELSES, our electronic-structure calculation code

Benchmark with upto 100M atoms or 100-nm-scale systems

( JPCM24, 165502(2012); JPSJ 82, 023710 (2013); JIP 24, 164 (2016) )

(a) Order- $N$  scaling

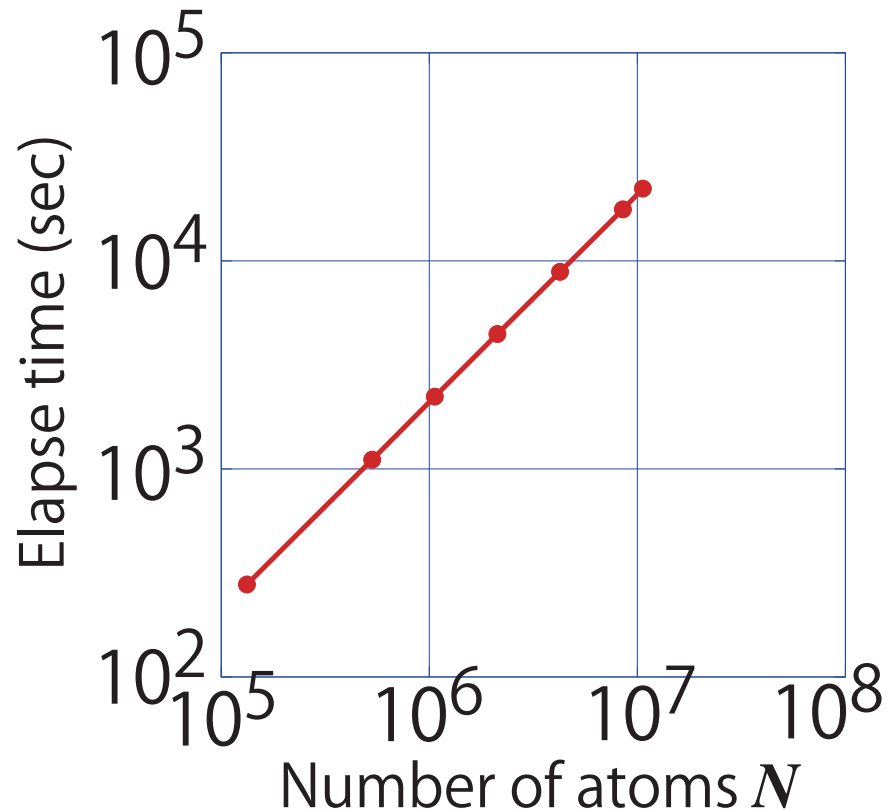

(b) Parallel efficiency (strong scaling) on the K computer ( ~ all nodes )

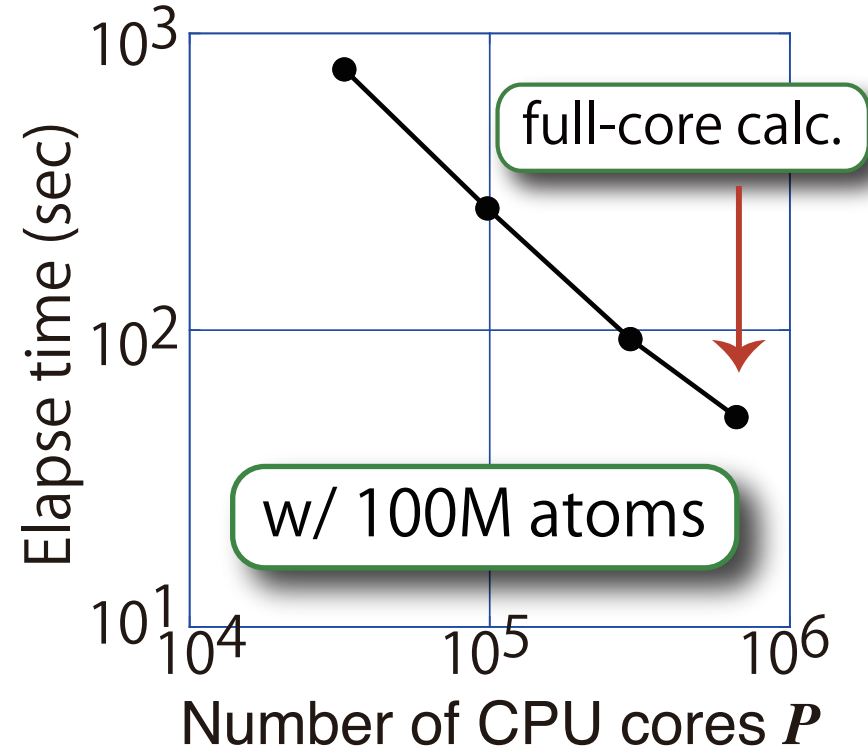

(a) amorphous-like conjugated polymer, poly-(9,9 dioctyl-fluorene),  
(b) sp<sup>2</sup>-sp<sup>3</sup> nano composite carbon solid

# ELSES, our electronic-structure calculation code

Benchmark with upto 100M atoms or 100-nm-scale systems

( JPCM24, 165502(2012); JPSJ 82, 023710 (2013); JIP 24, 164 (2016) )

(a) Order- $N$  scaling

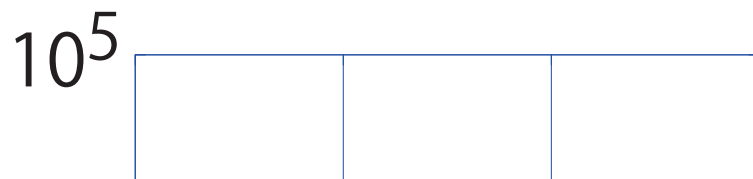

(b) Parallel efficiency (strong scaling) on the K computer ( ~ all nodes )

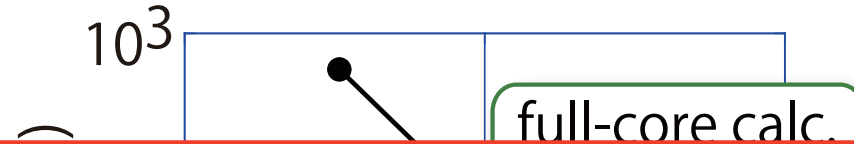

## Methodology

- Original linear-algebraic order- $N$  algorithms with generalized shifted linear equations

$$(zS - H)x = b$$

- Applicable both to metals and insulators
- Modelled (TB-type real-space) systems based on *ab initio* calc.,
- Options:
  - DFT-derived charge-self-consistent formulation
  - van-der-Waals correction



# Application-Algorithm-Architecture co-design

## Workflow

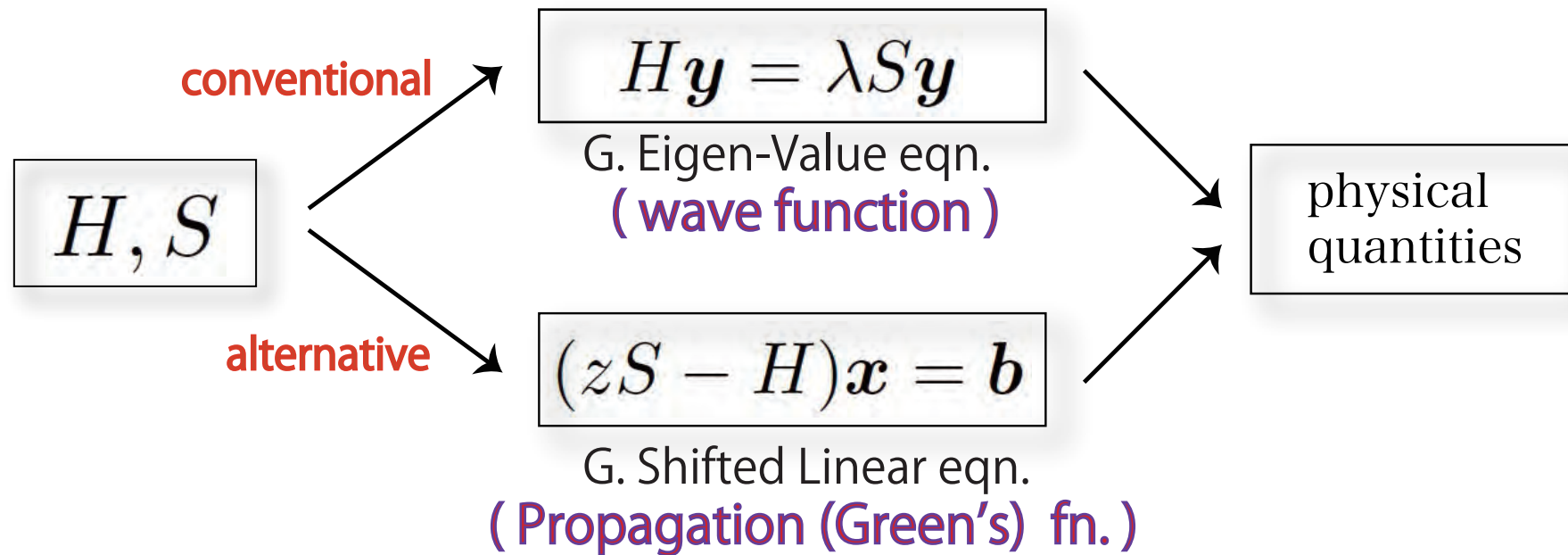
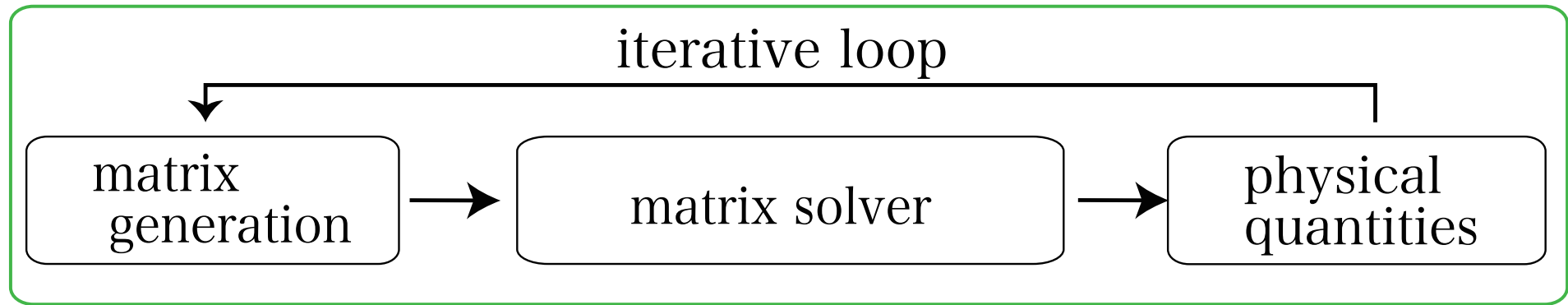

The algorithmic strategy is general and was applied to many scientific areas in parallel computation era (2000's ~ )

Use of the shifted linear equation with novel sparse-matrix (Krylov-subspace) solvers

[1] **A. Frommer, Computing 70, 87 (2003)**

Proof of a mathematical theorem (Collinear residual theorem), application to **QCD**

[2] R. Takayama, T. Hoshi, T. Sogabe, S.-L. Zhang, and T. Fujiwara,

Phys. Rev. B 73, 165108 (2006). → **large scale electronic structure calc. (this work)**

[3] S. Yamamoto, T. Fujiwara, and Y. Hatsugai, Phys. Rev. B 76, 165114 (2007);

S. Yamamoto, T. Sogabe, T. Hoshi, S.-L. Zhang and T. Fujiwara,

J. Phys. Soc. Jpn., 77, 114713 (2008).

→ **many-body electron theory [full-CI type, La<sub>3</sub>/2Sr<sub>1</sub>/2NiO<sub>4</sub>]**

[4] S. Iwase, T. Hoshi, T. Ono, Phys. Rev. E 91, 06330 (2015)

→ **ab initio transport calculation**

[5] F. Giustino, M. L. Cohen, S. G. Louie, Phys. Rev. B. 81, 115105 (2010)

→ **ab initio excitation (GW) calculation**

[6] T. Mizusaki, K Kaneko, M. Honma, T. Sakurai, Phys. Rev.C 82, 024310 (2010)

→ **nuclear physics**

# Highly parallelizable mathematical structure

Generalized eigen-value problem

$$H\mathbf{y}_k = \lambda_k S\mathbf{y}_k \quad (1)$$

Physical quantity with a given matrix  $X$   
(Ex. the case of  $X = H$   
--> Electronic structure energy)

$$\langle X \rangle \equiv \sum_k f(\lambda_k) \mathbf{y}_k^\dagger X \mathbf{y}_k \quad (2)$$

with a given weight function  
(‘Fermi distribution function’)

$$f(\lambda) \equiv \frac{1}{\exp(\beta(\lambda - \mu)) + 1} \quad (3)$$

( $\beta, \mu$  : given parameters)

Physical quantity in trace form

$$\langle X \rangle = \text{Tr}[X\rho] \quad (4)$$

with the density matrix

$$\rho \equiv \sum_k f(\lambda_k) \mathbf{y}_k \mathbf{y}_k^\dagger \quad (5)$$

Decomposition of the trace form

$$\text{Tr}[\rho X] = \sum_j \underbrace{\mathbf{e}_j^\dagger \rho X \mathbf{e}_j}_{\text{‘projected physical quantity’}} \quad (6)$$

**‘projected physical quantity’  
calculated in parallelism**

with  $\mathbf{e}_j$  (j-th unit vector)

$$\mathbf{e}_j \equiv (0, \dots, 0, 1_j, 0, \dots, 0)^\dagger \quad (7)$$

# Highly parallelizable mathematical structure

## Simplified explanation

→ decomposition of the trace form

$$\text{Tr}[A] = A_{11} + A_{22} + \dots + A_{MM}$$

parallel computation

(4)

(5)

(6)

quantity  
'ism

(7)

( $\beta, \mu$  : given parameters)

$e_j \equiv \dots 0, \dots, 1, \dots$

# Examples of nanomaterial simulation with ELSSES

Organic device materials  
(with Sumitomo Chemical Co.)

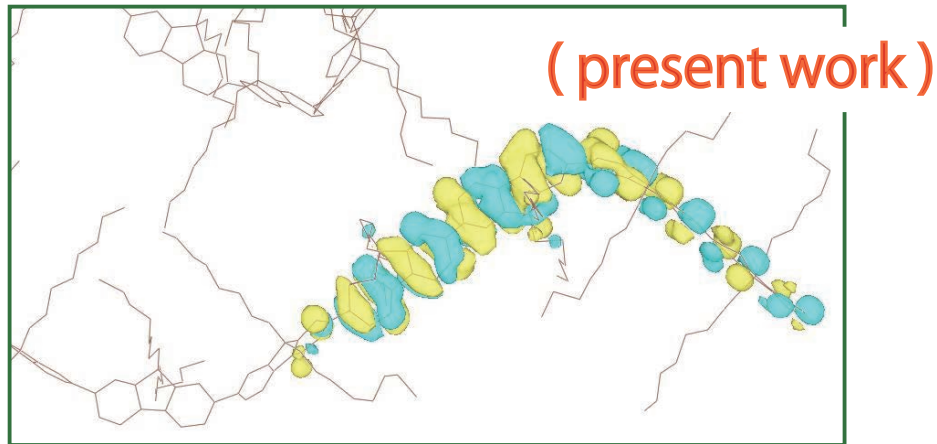

Battery material (with Toyota)

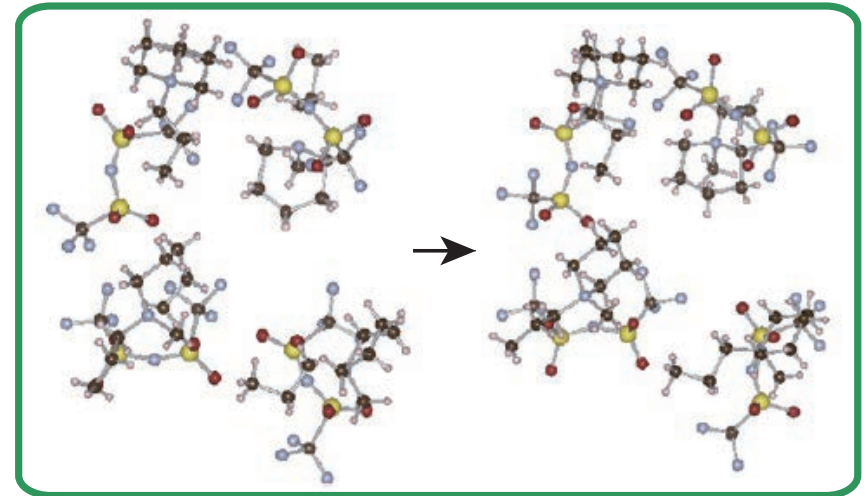

Ultra-hard diamond (nano-composite carbon)

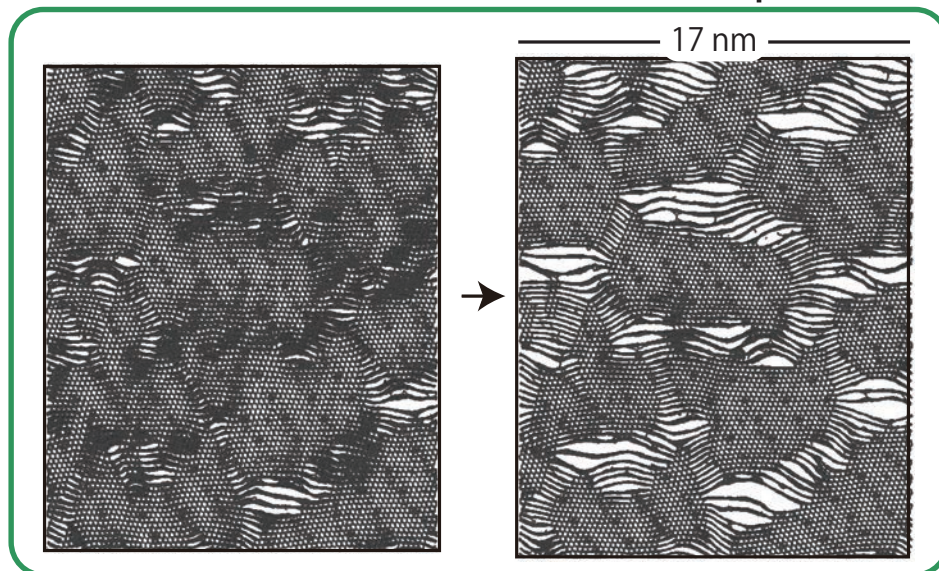

helical metal  
nanowire

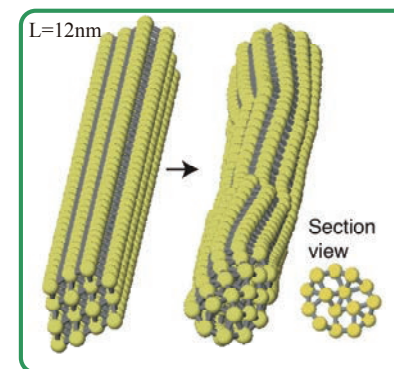

silicon fracture

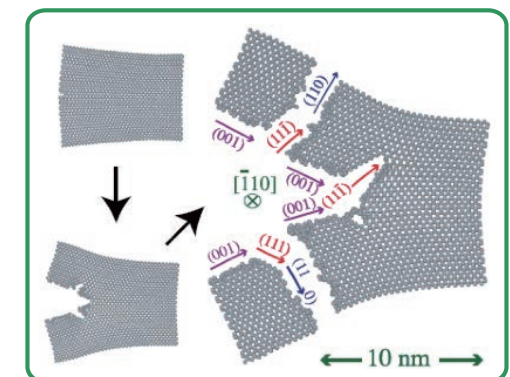

# 100M atom electronic structure calculation of organic device materials on full system of K Computer

Takeo Hoshi and Hiroto Imachi (Tottori U)

1. Introduction : organic device materials
2. Method
3. Result
4. Comment on futher collaboration  
between application and HPC researcher
5. Conclusion

---

## Acknowledgement for colloboration

Organic materials : M. Ishida ( Sumitomo Chemical Co. )

Mathematics: : T. Sogabe, S. L. Zhang ( Nagoya U )

Tuning (recent) : K. Kumahata, M. Terai, K. Miyamoto, K. Minami, F. Shoji (RIKEN-AICS)

National project : 'Post K' application project

# Quantum (wavepacket) dynamics for device simulation

Non-equilibrium, non-stationary simulation

Solving an effective Schrodinger-type equation (details are not yet settled)

$$i \frac{\partial \psi}{\partial t} = H \psi \quad (1)$$

$$\psi \equiv \psi(\mathbf{r}, t) \quad (2)$$

: electronic 'wave'  
(ex. hole wave packet)

$$\rho(\mathbf{r}, t) \equiv |\psi(\mathbf{r}, t)|^2 \quad (3)$$

: charge distribution (real value)

→ calculation of  
device performance  
or 'mobility' value

Example of a partial region  
of a polymer;

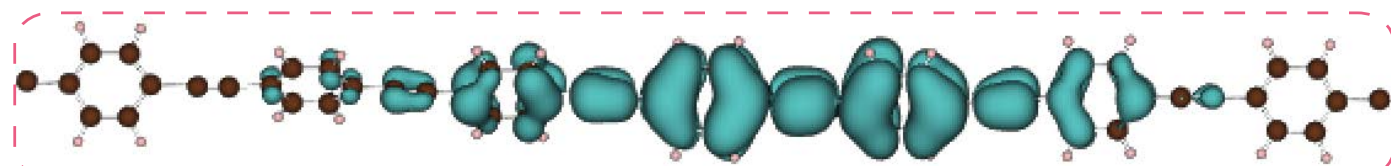

Close-up

↓ 5 ps

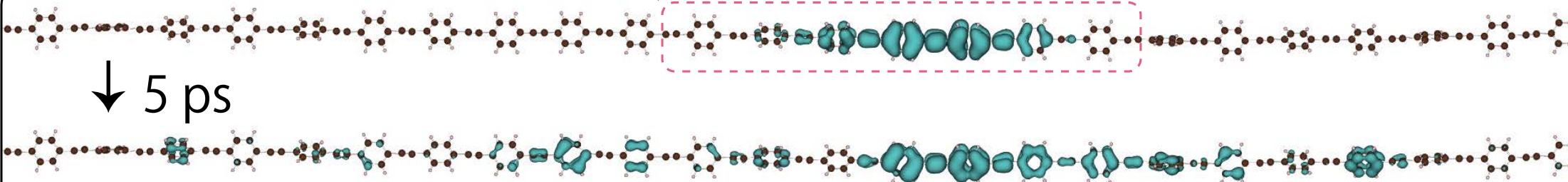

# Comparizon between linear and zigzag chain structures

poly(phenylene–ethynylene) ([1] J. Terao, et al, Nature Comm. 4, 1691 (2013))

→ The static and dynamical disorders  
are essential for device performance (mobility value)

linear

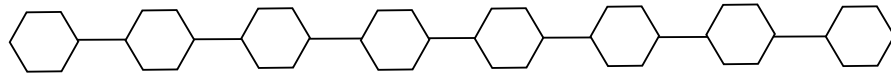

zigzag

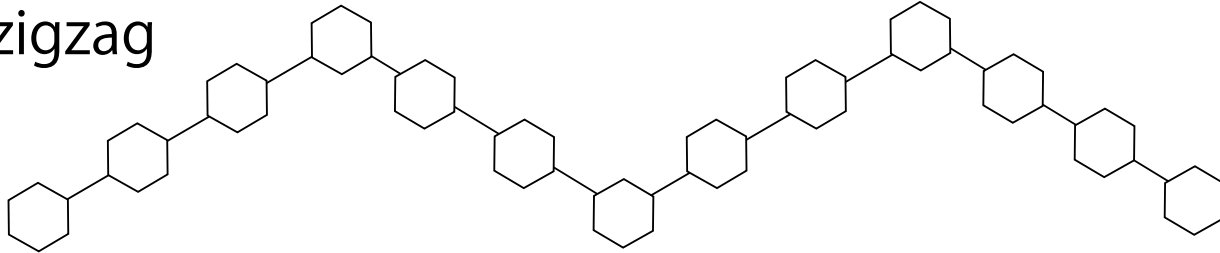

example ( linear chain )

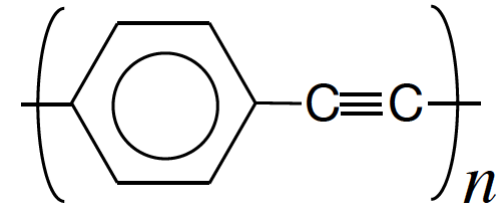

Result

mobility in ideal structure

(linear) > (zigzag)

mobility in realistic (disordered) structure

(linear) < (zigzag)



# Recent work : 100-million-atom caulation of condensed organic polymers

thanks to M. Ishida (Sumitomo Chemical Co.)

(a) material: poly-(phenylene-ethynylene) (PPE)

(size  $\approx$  200nm, P=100,000 polymers)

Figure of a partial reition ( $\sim$ 50nm)

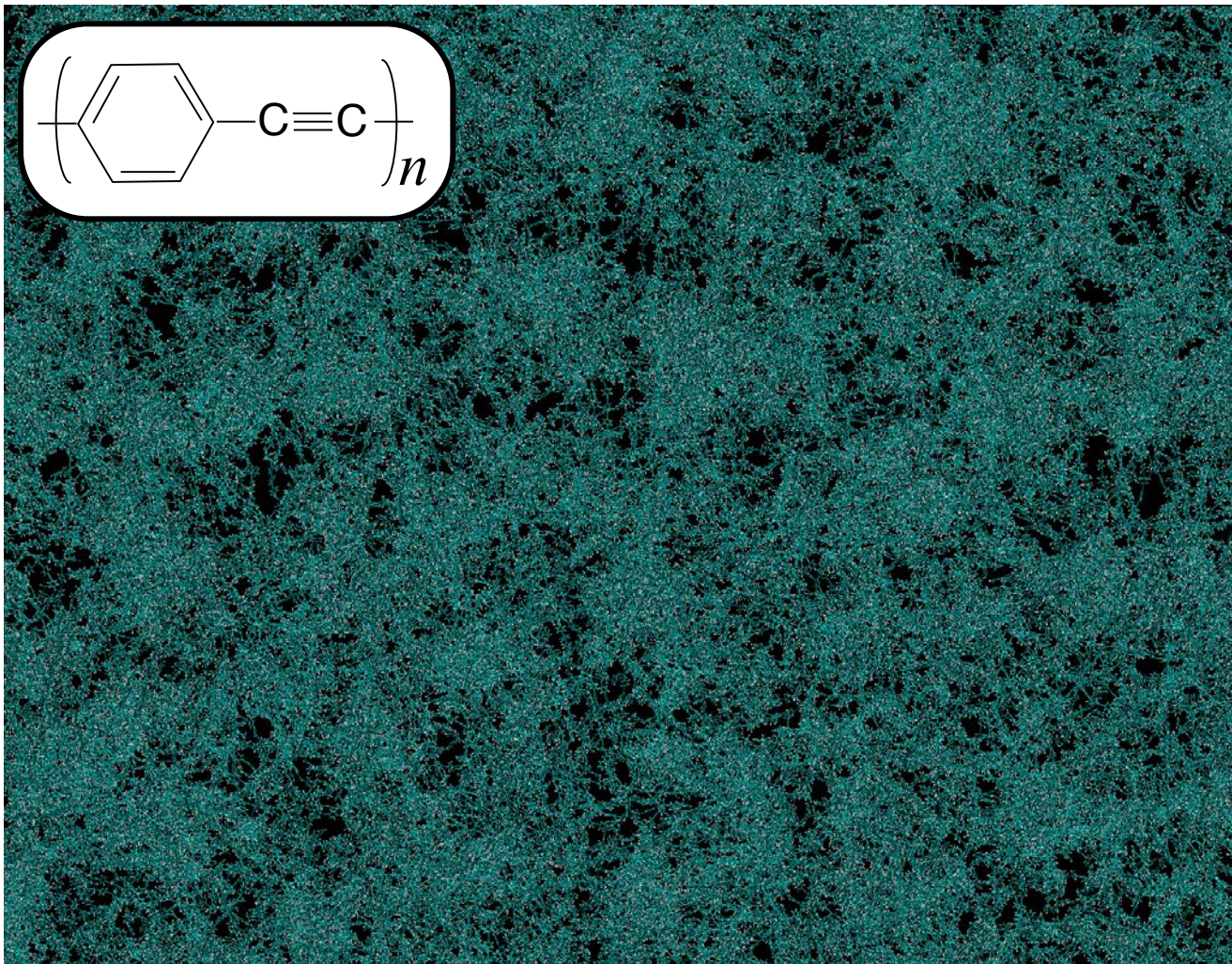

(b) Quantum dynamics

Fig: Charge dynamics with 1 ps

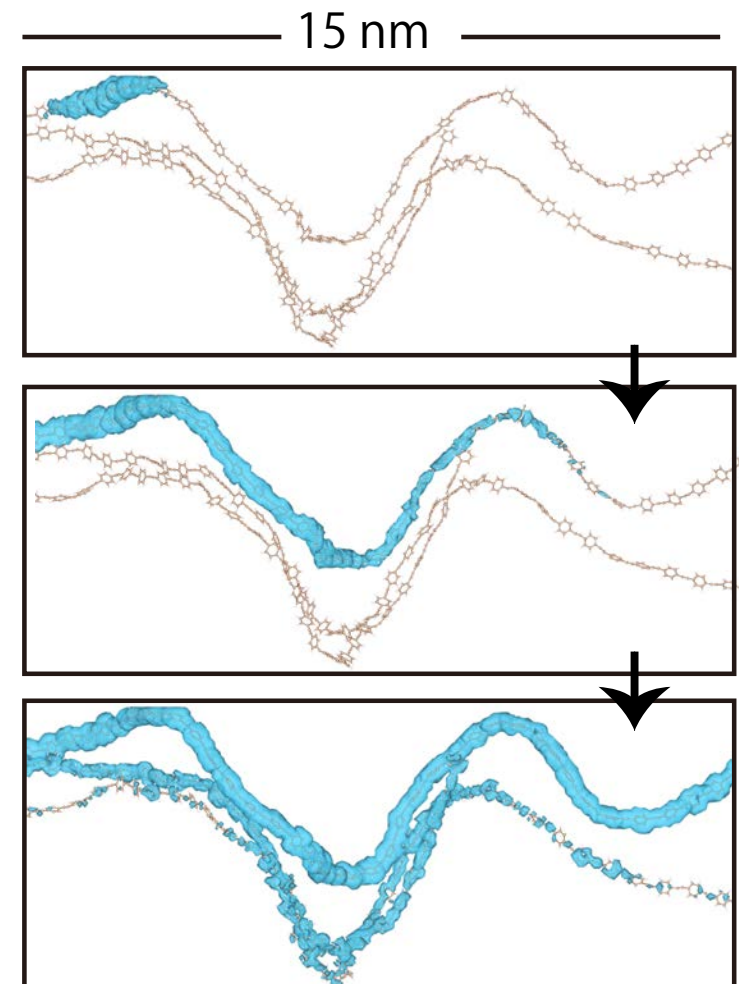

# Recent work : 100-million-atom caulation of condensed organic polymers

thanks to M. Ishida (Sumitomo Chemical Co.)

(a) material: poly-(phenylene-ethynylene) (PPE)

(size  $\approx$  200nm, P=100,000 polymers)

Figure of a partial reition (close-up ( $\sim$ 10nm))

(b) Quantum dynamics

Fig. Charge dynamics with 1 ps

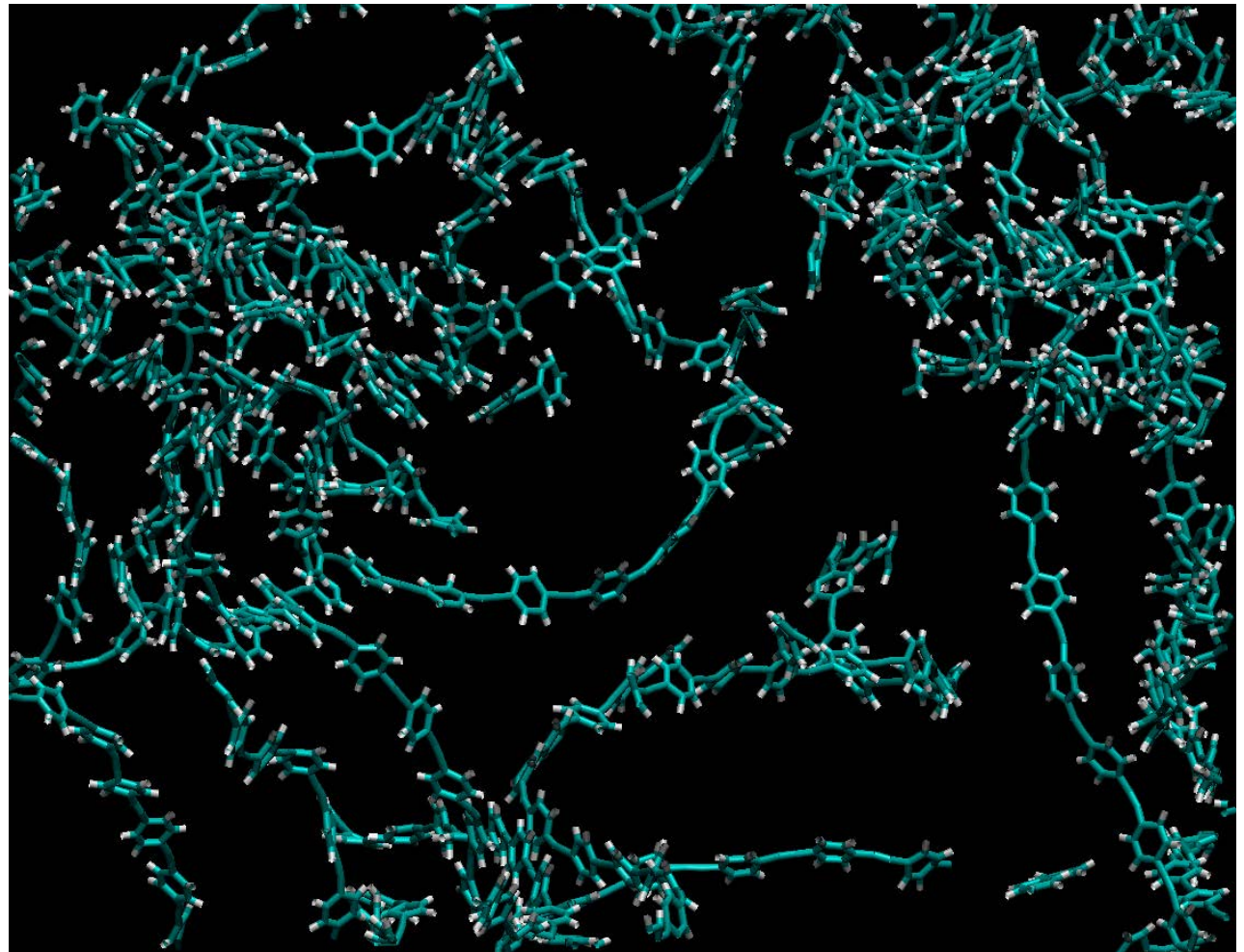
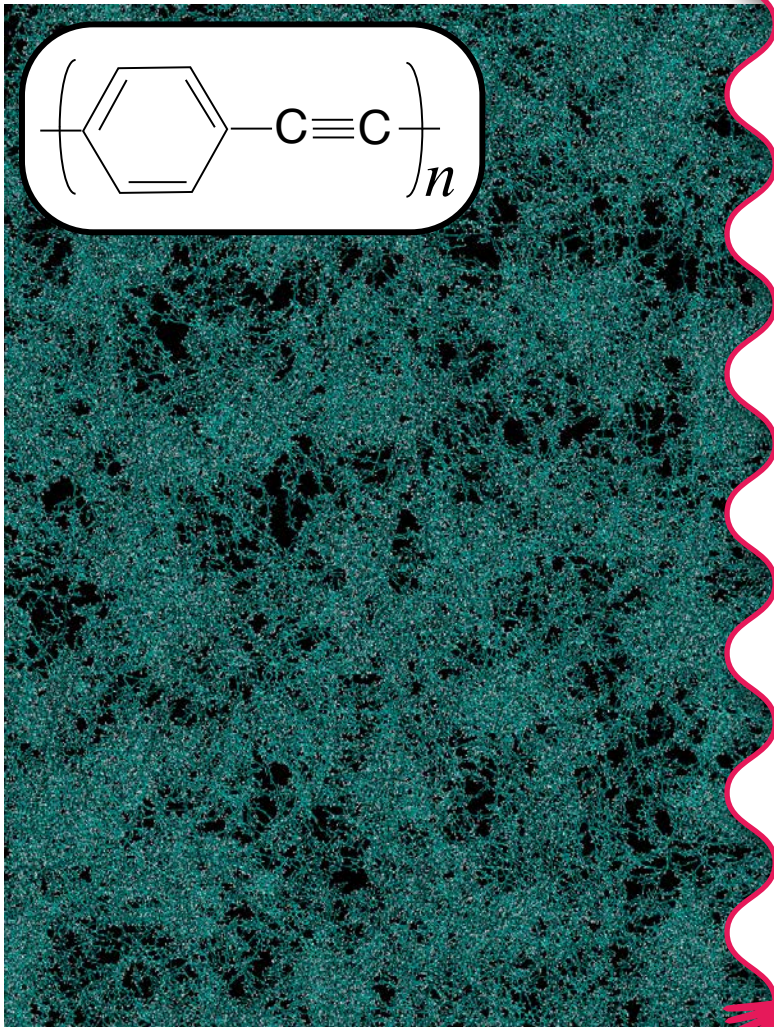

# 100M atom electronic structure calculation of organic device materials on full system of K Computer

Takeo Hoshi and Hiroto Imachi (Tottori U)

1. Introduction : organic device materials
2. Method
3. Result
4. Comment on further collaboration  
between application and HPC researcher
5. Conclusion

---

## Acknowledgement for collaboration

Organic materials : M. Ishida ( Sumitomo Chemical Co. )

Mathematics: : T. Sogabe, S. L. Zhang ( Nagoya U )

Tuning (recent) : K. Kumahata, M. Terai, K. Miyamoto, K. Minami, F. Shoji (RIKEN-AICS)

National project : 'Post K' application project

Comments on possible further collaboration  
between application and HPC researchers

(1) Developing a mini-appli with general numerical solvers

our example:

- 'Eigenkernel' (a parallel dense matrix solver)

H. Imachi and T. Hoshi, J. Inf. Process. 24, 164 (2016)

<https://github.com/eigenkernel/>

- project for sparse-matrix solver is in progress

(2) Convergence of simulation and data analysis

→ integrated as 'service' on supercomputer for industrial researchers

our case:

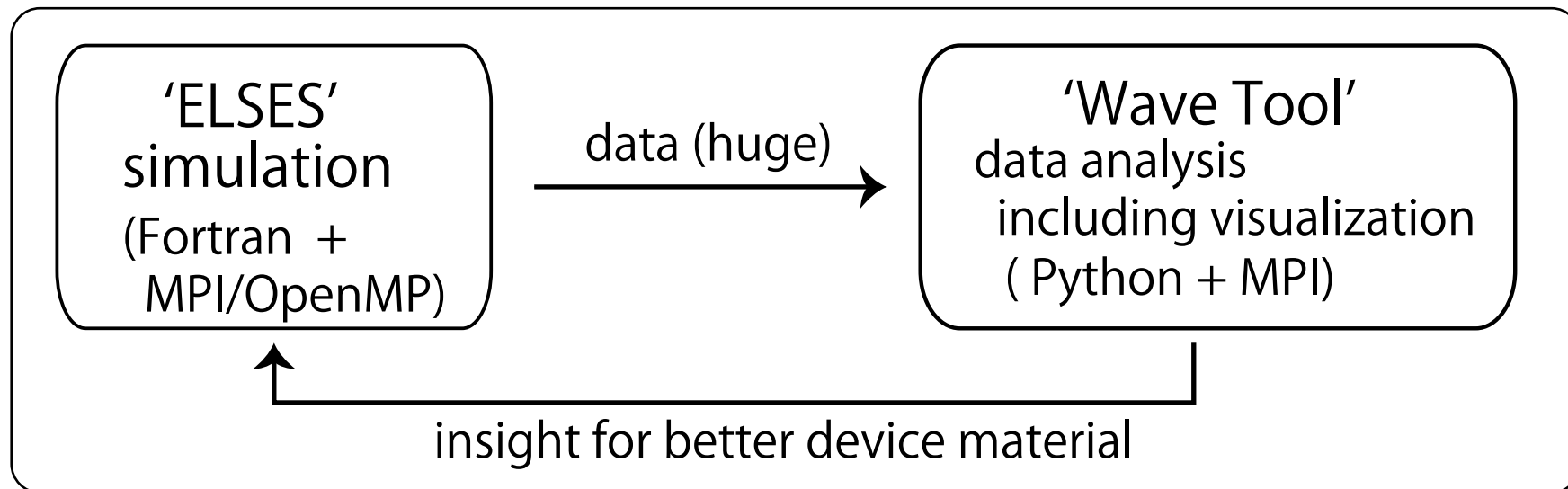

## Summary

Preliminary results appear on our preprint: <http://arxiv.org/abs/1603.09616>

- (1) Organic material  
→ flexible device and IoT products
- (2) Simulation: 'ELSESES'
  - 100-million-atom  
(100-nm-scale, largest)  
electronic structure calculation
  - strong scaling up to  
the full system of the K computer
  - quantum dynamics  
→ device simulation
- (3) Result
  - organic polymer
  - condensed polymers
- (4) Comment on future colaboration  
between application and HPC peoples

